

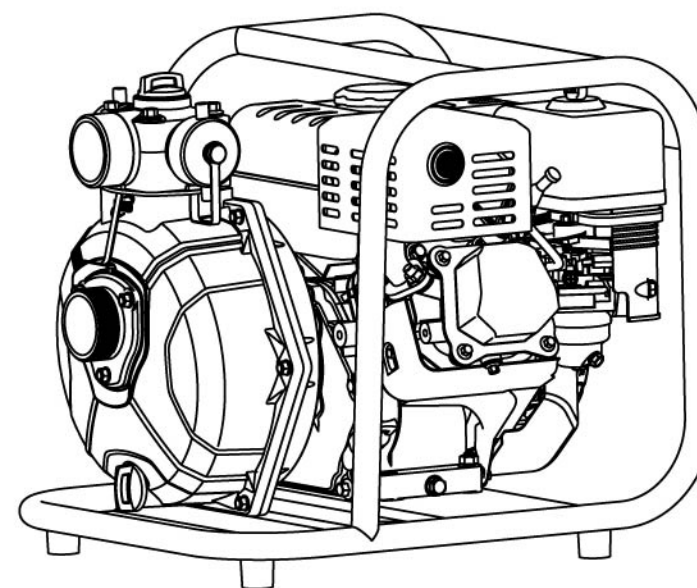

Gasoline Water Pump

Original Instruction Manual



LEO GROUP PUMP(ZHEJIANG) CO.,LTD.

Add: No.1,3rd Street, East Industry Center,317500

Wenling City, Zhejiang P.R.China

Tel: 0086-576-89986360

Fax: 0086-576-89989898

Email:export@leogroup.cn

www.leogroup.cn

• LGP20-H • LGP20-2H

CONTENTS

1. Safety information	3
2. Location of warning labels	4
3. Name of every part.....	5
4. Pre-starting operation	6
5. Starting the engine	9
6. Stopping the engine.....	11
7. Maintenance.....	12
8. Troubleshooting	15
9. Storage	16
10. Specifications	17

10. Specifications

Model	LGP20-H	LGP20-2H
Dimensions and Weight		
Total length	463 mm	463 mm
Total width	398 mm	398 mm
Total height	406 mm	406 mm
Dry weight	22.22 kgs	22.24 kgs
Engine		
Model	168F-2	
Engine type	Single cylinder, 4-stroke, forced air-cooled, OHV	
Rated power	6.5 HP	
Displacement	196 cc	
(Bore X Stroke)	(68 x 54 mm)	
Ignition system	TCI	
Rotation direction	Counterclockwise	
Idle speed	1400 ± 150 rpm	
Fuel consumption	≤395 g/kW•h	
Gasoline	90 or higher, unlead	
Pump		
Inlet/Outlet	50 mm (2")/2x38 mm (1.5") + 1x50mm (2")	
Maximum head	55 m	80 m
Suction	6 m/120 s	6 m/120 s
Maximum flow	30 m ³ /h	20 m ³ /h

NOTE: Specifications are subject to change due to technical improvements without prior notice.

9. Storage

Let the pump cool down. Wait at least 30 minutes after it stops. Clean the pump and coat rust-proof grease if necessary.

CAUTION

The cleaning water under pressure may go into air filter and muffler, or even go into cylinder which will result in corrosion damage.

Before storing the pump for over 14 days:

- 1). Make sure the storage area is free of moisture and dust.
- 2). Drain off the fuel.
 - a. Turn off the fuel valve and remove the drain screw. Drain the fuel into a suitable container.
 - b. Turn off the fuel valve and drain the fuel into a suitable container.
 - c. Reinstall the drain screw.
- 3). Reinstall the fuel cup and drain screw and tighten them.
- 4). Replace engine oil.
- 5). Remove the spark plug.
- 6). Pour one spoon of clean engine oil (5-10 ml) into cylinder.
- 7). Pull the starter cord to distribute the oil inside the cylinder.
- 8). Reinstall the spark plug.
- 9). Pull up the starter handle until a resistance is felt. In that case, both the inlet valve and outlet valve is closed to prevent corrosion inside the engine. Pull back the starter handle gently.
- 10). Cover up the pump to keep out dust.

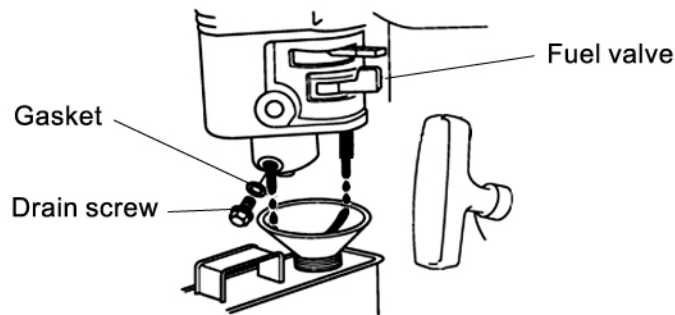

This appliance can be used by children aged from 8 years and above and persons with reduced physical, sensory or mental capabilities or lack of experience and knowledge if they have been given supervision or instruction concerning use of the appliance in a safe way and understand the hazards involved.

Children shall not play with the appliance. Cleaning and user maintenance shall not be made by children without supervision.

Attention!

If the appliance or the supply cord is damaged, it must be repaired by manufacturer, its service agent or qualified person.



Meaning of crossed –out wheeled dustbin:
Do not dispose of electrical appliances as unsorted municipal waste, use separate collection facilities.
Contact you local government for information regarding the collection systems available.

Thank you for purchasing this LEO gasoline engine pump.

This instruction manual describes the installation, usage and maintenance of our water pump and provides important safety information. Keep your manual in a convenient place for quick reference.

This manual should be considered as a permanent part of this water pump and should remain with the pump if it is sold.

Please take care of the information with following typical symbols:

▲ DANGER

This symbol indicates a hazardous situation which, if not avoided, will result in death or serious injury.

▲ WARNING

This symbol indicates a hazardous situation which, if not avoided, could result in death or serious injury.

▲ CAUTION

This symbol indicates a hazardous situation which, if not avoided, could result in minor or moderate injury.

IMPORTANT: This symbol indicates a potentially hazardous situation which, if not avoided could result in property damage.

NOTE: This symbol indicates useful information.

The warning and safety instructions appearing in this manual are not meant to cover all possible conditions and situations that may occur. Common sense, caution and care must be exercised when operating or cleaning tools and equipment. Always contact your dealer, distributor, service agent or manufacturer about problems or conditions you do not understand before operating the product.

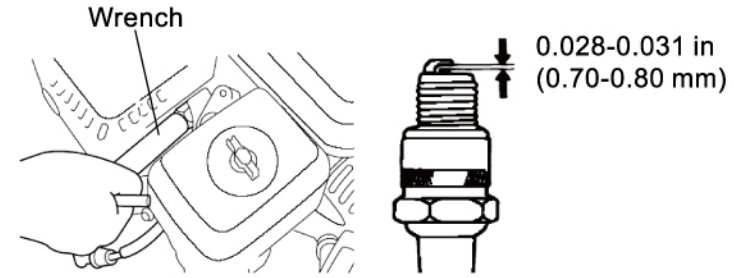

8. Troubleshooting

The engine will not start:

1. Is there enough fuel?
2. Is the fuel valve ON?
3. Has the fuel reached the carburetor?

To check, remove the oil drain screw and turn the fuel valve on.

▲ DANGER

Should there be a spill of fuel, be sure to clean it before checking the spark plug or start the engine. Otherwise the spilled fuel or fuel vapor may get ignited.

4. Is the engine switch ON?
5. Is there enough engine oil or does the oil exceed the upper level?
6. Is the spark plug generating sparks?

Uninstall and check the spark plug, clear off the dirt from around the plug and dry it. Fit the spark plug into the plug cap. Replace the spark plug if necessary.

7. If the engine still refuses to get started, contact an authorized dealer.

The pump does not pump water:

1. Is it filled with enough amount of water (2 L)?
2. Is the strainer clogged?
3. Is the hose clamp tightened?
4. Is the suction hose damaged?
5. Is the suction head too high?
6. If the pump still fails to work, contact an authorized dealer.

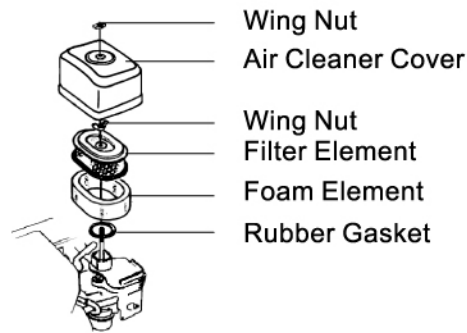

Cleaning filter element:

Slightly tap the filter element a few times, then blow it with compressed air (pressure ≤ 207 KPa) from inside. Do not clean the filter element with brush, which will block the air passages of the element.

Cleaning foam filter element:

Wash the element in hot water with detergent or in a non flammable or high flash point solvent. Let it dry thoroughly and immerse it into clean oil and then squeeze out the excess oil.

- 5). Clean the lower part of air cleaner, air cleaner cover and rubber gasket.
- 6). Combine the filter element and foam filter element.
- 7). Reinstall the air cleaner element and the cover.

Maintaining the spark plug

The recommended type of spark plug is F7RTC

⚠ CAUTION

Take care not to touch the muffler due to high temperature on it's surface when the engine is running or just stops.

- 1). Remove the plug cap.
- 2). Remove the spark plug by the wrench.
- 3). Visually check the spark plug. Discard it if the electrode or insulation ring is damaged or the insulator is broken or cracked. Check the plug gap with a feeler gauge. The gap should be 0.70 - 0.80 mm. Vary the gap by moving the side electrode if necessary.
- 4). Thread the plug in by hand to prevent cross-threading.
- 5). Tighten the spark plug with the wrench to compress the washer.
- 6). Reinstall plug cap.

⚠ WARNING

1. Safety information

User's responsibility

- Before using this product, carefully read and fully understand this instruction manual for proper operation and safety procedures. Failure to follow all instructions may result in personal injury or product damage.
- Be sure that you are familiar with quick stop procedures and control operation of the water pump.
- This machine shall be operated by adults only! Keep children and pets away from the working area.
- This pump is designed to transfer clean water. Never attempt using this pump to deliver dirty water or slurry, or any inflammable or corrosive liquids.
- Do not touch the hot muffler while the machine is working. Move the machine when it's stopped and cooled down.
- To prevent fire hazards, keep at least 1 meter of clearance on all sides of this machine during operation.

⚠ DANGER

Adding gasoline

- Gasoline is highly flammable and explosive. Always shut down this machine before refueling. Refuel in a well-ventilated area. Make sure the filler cap is securely closed after refueling.
- No smoking is allowed and no open fire or sparks allowed to exist in areas where fueling is carried out or the fuel is stored.
- Be sure to remove the spilled gasoline as by wiping before starting this machine.

⚠ DANGER

Carbon monoxide gas

- When in operation, the exhaust from this machine contains poisonous carbon monoxide gas. Breathing this poison gas can lead to eventually death. Use this machine ONLY outdoors in well-ventilated areas.

2. Location of warning labels

These warning labels indicate potentially hazardous situations which could result in serious injury. Please carefully read and understand the symbols, safety information and precautions.

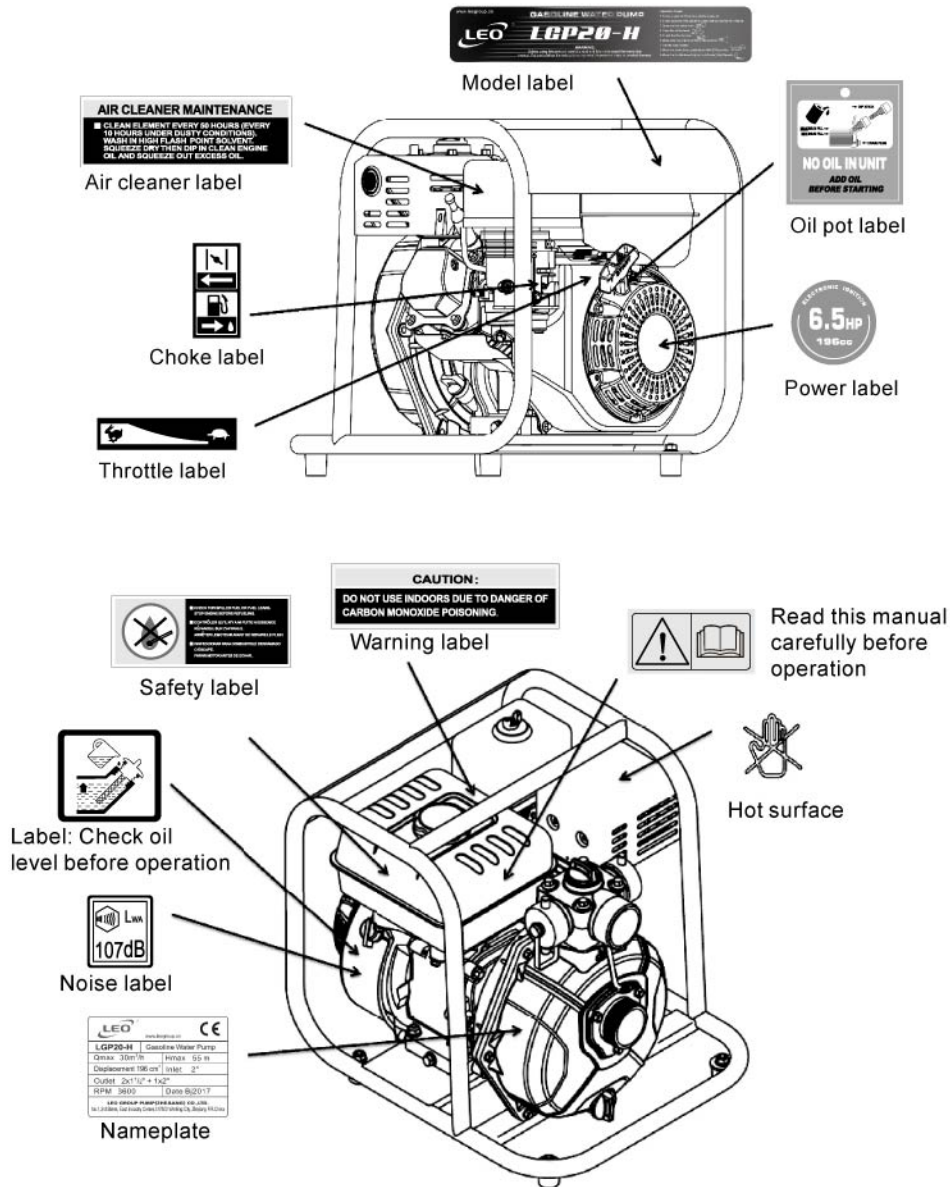

Changing engine oil

Warm up the engine and drain the oil to assure rapid and complete draining.

- 1). Remove the oil dipstick and the drain screw, then drain the oil.
- 2). Reinstall the drain screw and tighten it.

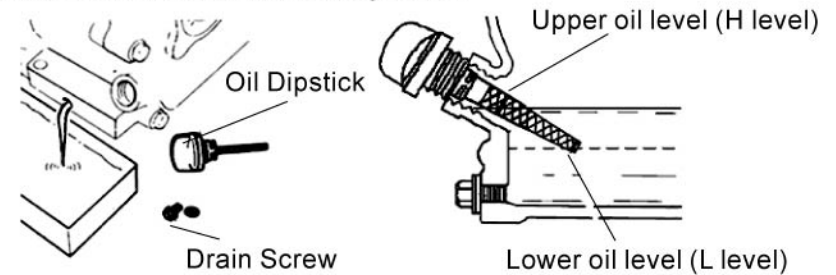

NOTE: Be sure to keep the environment clean when disposing used engine oil. We suggest you collect the waste oil in a container to be sent to a waste disposal site or a recycling service center instead of spilling it in the garbage or on the ground.

- 3). Place the engine in a level position and refill with recommended oil with capacity of 700 l. (See page 6)
- 4). Reinstall the oil dipstick and tighten it.

Maintaining the air cleaner

A dirty air cleaner will restrict air flow to the carburetor and result in less pump power. Service the air cleaner periodically to prevent carburetor malfunctions. More frequent maintenance will be necessary if the pump is working in an extremely dirty environment.

CAUTION

Never run the pump without an air cleaner or with a damaged air cleaner. The dirt or dust if sucked into the engine may quicken engine wear.

- 1). Unscrew the wing nut and remove the air cleaner cover.
- 2). Unscrew the wing nut and remove filter element and foam element.
- 3). Separate filter element from foam element.
- 4). Replace the element if damaged. Replace the paper filter element in accordance with maintenance schedule.

3). Turn the fuel valve OFF.

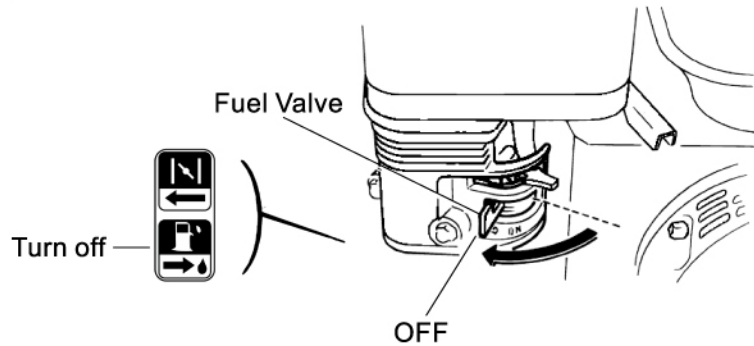

7. Maintenance

Maintenance Schedule

REGULAR SERVICE PERIOD		Each time	20 Hrs or first month	50 Hrs or every 3 months	100 Hrs or every 6 months	300 Hrs or every year
Engine oil	Check level	O				
	Change		O		O	
Air cleaner element	Check	O				
	Clean			O(1)		
	Change					O*
Fuel sediment cup	Clean				O	
Spark plug	Clean				O	Change
Valve clearance	Readjust					O(2)
Fuel tank and fuel filter	Clean	Every 2 years (2)				
Fuel line	Change	Every 2 years (2) (between fuel tank and carburetor)				

*:Change paper filter element only.

(1): Service more frequently when used in dusty areas.

(2): These items should be serviced by an authorized dealer, unless the owner has the proper tools and is mechanically proficient.

3. Name of every part

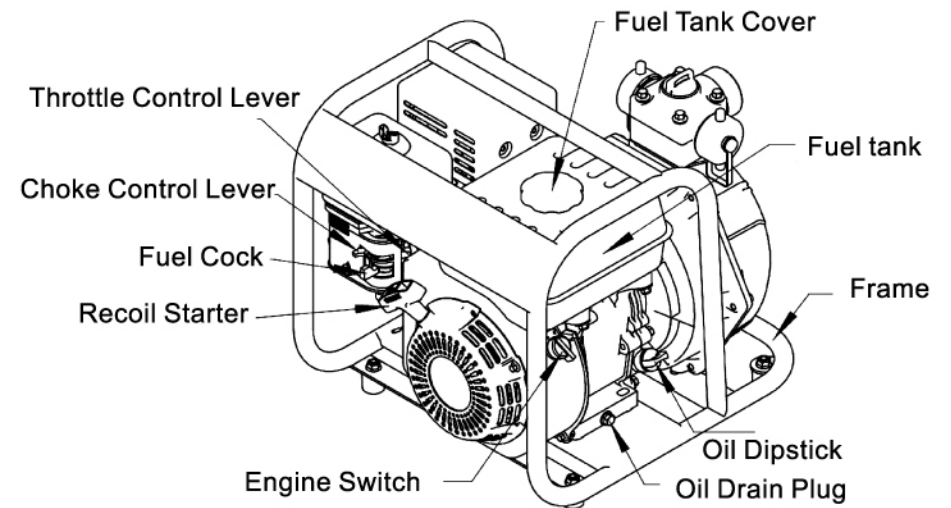
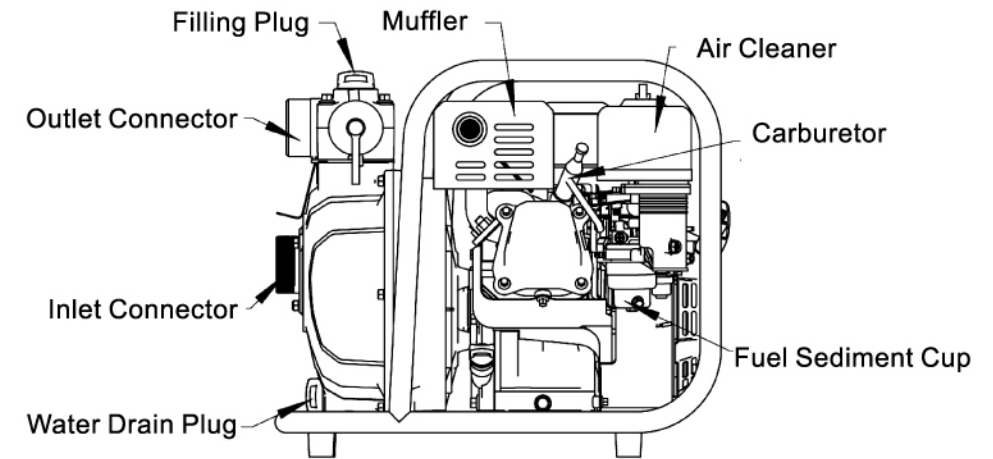

4. Pre-starting operation

IMPORTANT: Install the strainer on the end of the suction hose before operation. The strainer prevents foreign materials and protects the pump from block and component damages.

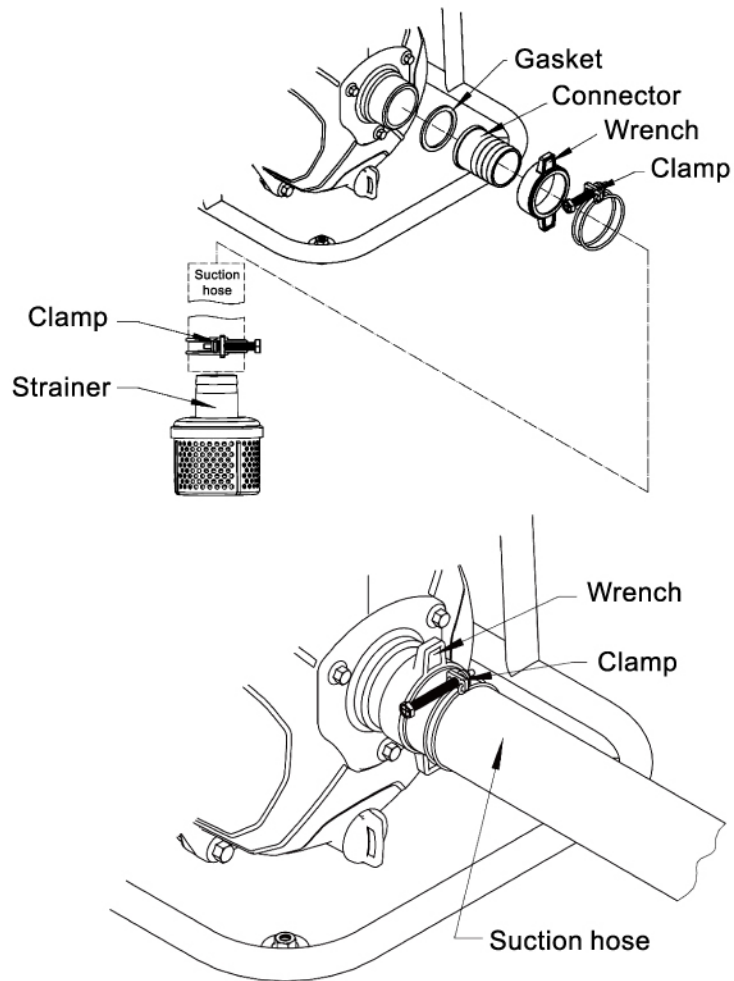

⚠ CAUTION

To start this water pump, please check the following before each use:

- Confirm that engine oil has been properly added.
- Confirm that gasoline has been properly added.
- Confirm that water with volume of 2L has been added in the pump housing. Dry running will damage the mechanical seal quickly.

7). Move the throttle lever fully to the left (high speed).

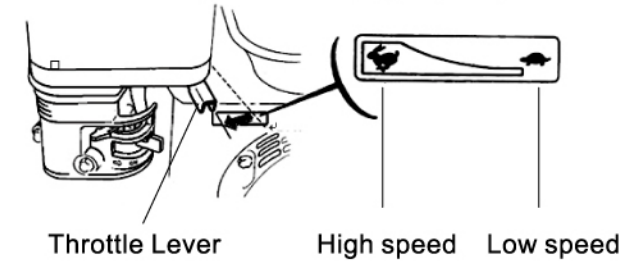

6. Stopping the engine

Please follow the steps below to stop the engine:

1). Move the throttle lever to the right end (low speed).

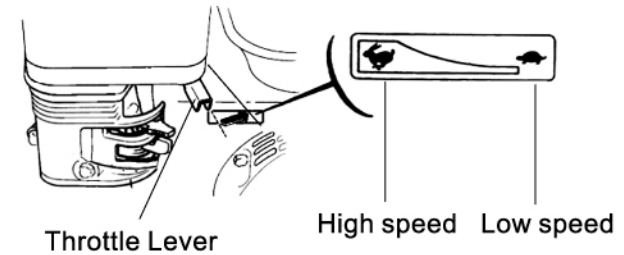

2). Turn the engine switch to the OFF position.

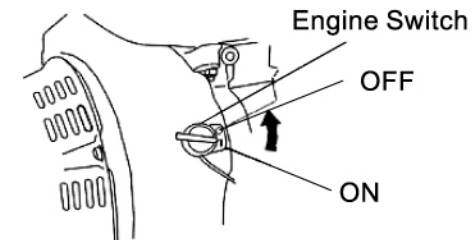

NOTE: Turn the engine switch to the OFF position immediately to shut down the engine in an emergency.

4). Turn the engine switch to the ON position.

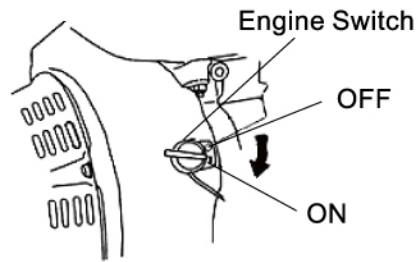

5). Pull the starter handle lightly until resistance is felt, and then pull it briskly.

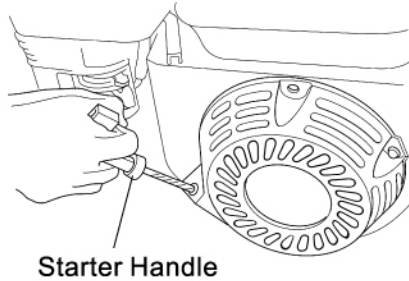

CAUTION

Return the starter handle gently to the starter. Do not allow to snap back against the engine.

6). Move the choke lever gradually to the ON position after the engine warms up.

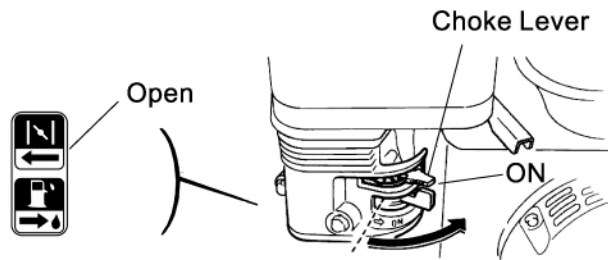

NOTE: Please use oil pot to add engine oil of 700 ml to the crankcase when the crankcase is empty.

Checking oil level (The pump must not in operation)

- Remove the oil dipstick from and wipe it dry.
- Insert the dipstick into the oil filler (but don't screw it in) to check the oil level.
- Replenish the crankcase with the recommended type of oil until the oil level comes up to the upper most position of the refilled (650 ml - 700 ml) if the existing oil level is found too low. Pump damage may occur if the oil level exceeds 700 ml.
- Insert the dipstick into the oil filler again and screw it in.

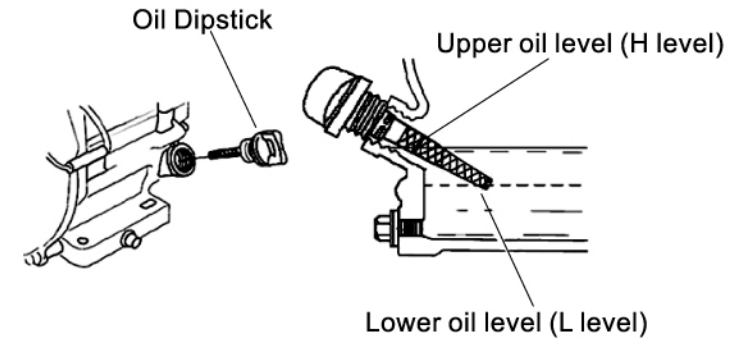

IMPORTANT: The Oil Shortage Alarm System is designed to avoid damage of the engine due to shortage of oil in the crankcase. The system will automatically shut down the engine just before the crankcase oil level drops down to the minimum line of safety.

Recommended oil type

SAE 10W-30

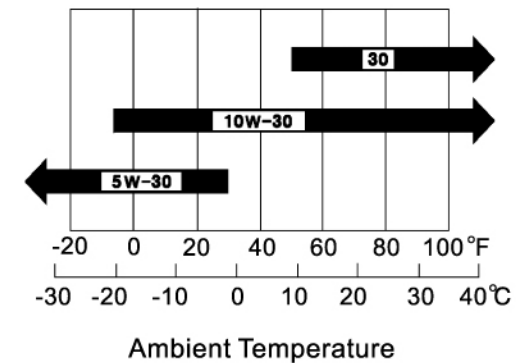

- 4-stroke engine oil.
- Use a high quality detergent oil classified "For Service SE" or higher.

- Choose a viscosity according to the table in different areas and different seasons.

Checking fuel level

Uncap the fuel tank and check the fuel level while the machine is not in operation. Pouring gasoline if the fuel level is found too low.

CAUTION

Do not allow the fuel to overflow the fuel tank. The maximum fuel level is shown as below. Wipe up any spilled gasoline with a dry cloth immediately.

Maximum fuel level

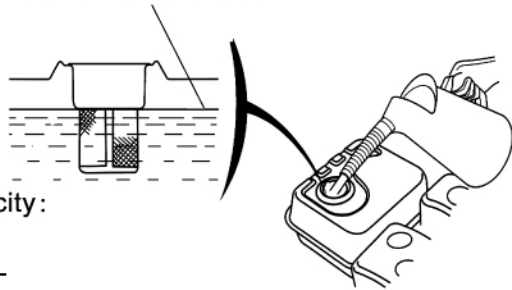

Fuel Tank Capacity:
LGP20-H: 2.8 L
LGP20-2H: 2.8 L

It is recommended to use fresh, unleaded gasoline with an octane rating of 90 or 93. Use of ethanol gasoline (more than 10% blended) is not allowed.

Checking and filling the pump with cooling water

The pump must be filled with priming water (not less than 2 L) before it is put to operation.

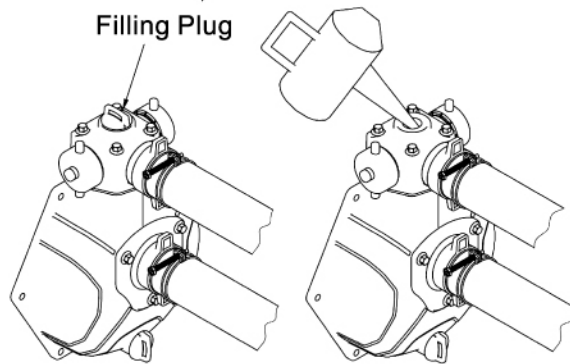

5. Starting the engine

CAUTION

Confirm that fresh engine oil has been properly added.

CAUTION

Confirm that gasoline has been properly added in the fuel tank.

CAUTION

Confirm that water has been properly added in the pump.

1). Turn the fuel valve ON.

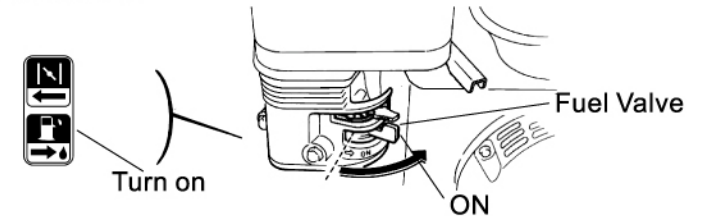

2). Close the choke lever.

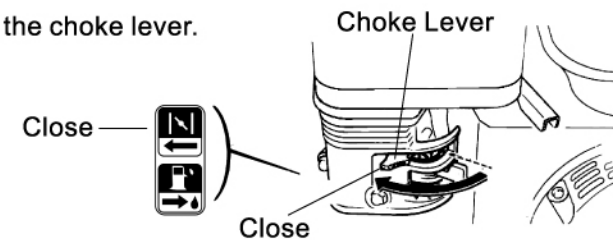

NOTE: In case the engine is warm or ambient temperature is high, it's not necessary to close the choke lever.

3). Move the throttle lever from left (low speed) to right (high speed) to keep about 1/3 distance from the right (high speed).

